

SHAFT HANDLING

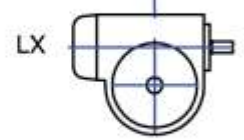

VERTICAL UP

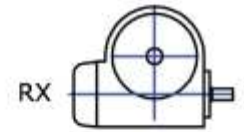
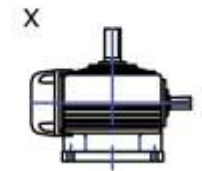
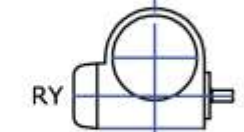
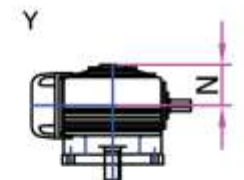

VERTICAL DOWN

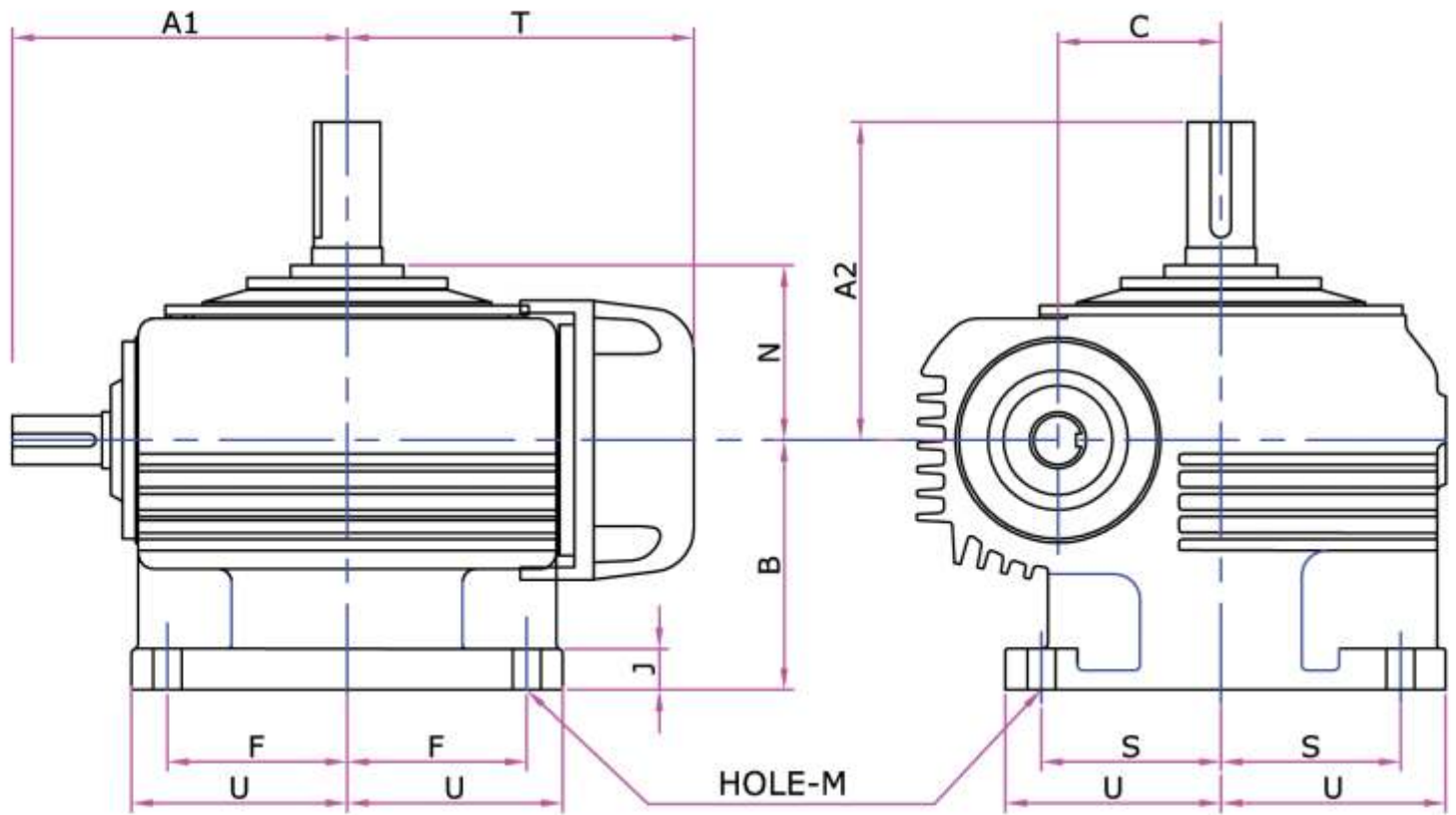
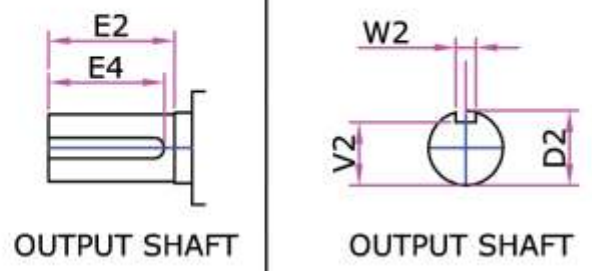
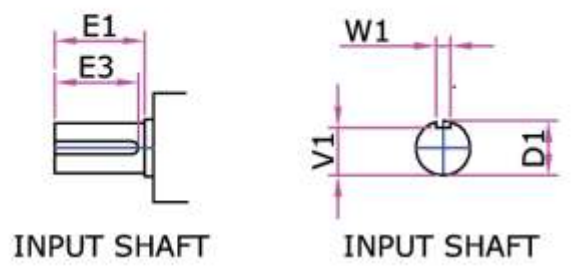

SIZE	C	B	A1	A2	E1	E2	D1	D2	M	N	J	F	S	U	T	E3	E4	W1	W2	V1	V2
100	100	172	227	252.5	65	110	32	44	18	119	32	114	114	143	231	60	105	10	14	27	38.5
127	127	192	261	248	70	98	38	52	22	133	35	140	140	170	270	65	90	10	16	33	46
152	152	199	280	267	74	112	38	58	22	142	25	150	150	185	284	70	105	10	16	33	52
180	180	205	322	300	90	125	45	62	22	153	35	175	175	210	315	80	110	14	18	39.5	55
205	205	215	347	290	90	138	45	70	22	145	32	200	200	240	350	80	120	14	20	39.5	61